



# 2in1

Kerb and  
Drainage

For the linear  
bridge drainage

ACO DRAIN® KerbDrain Bridge



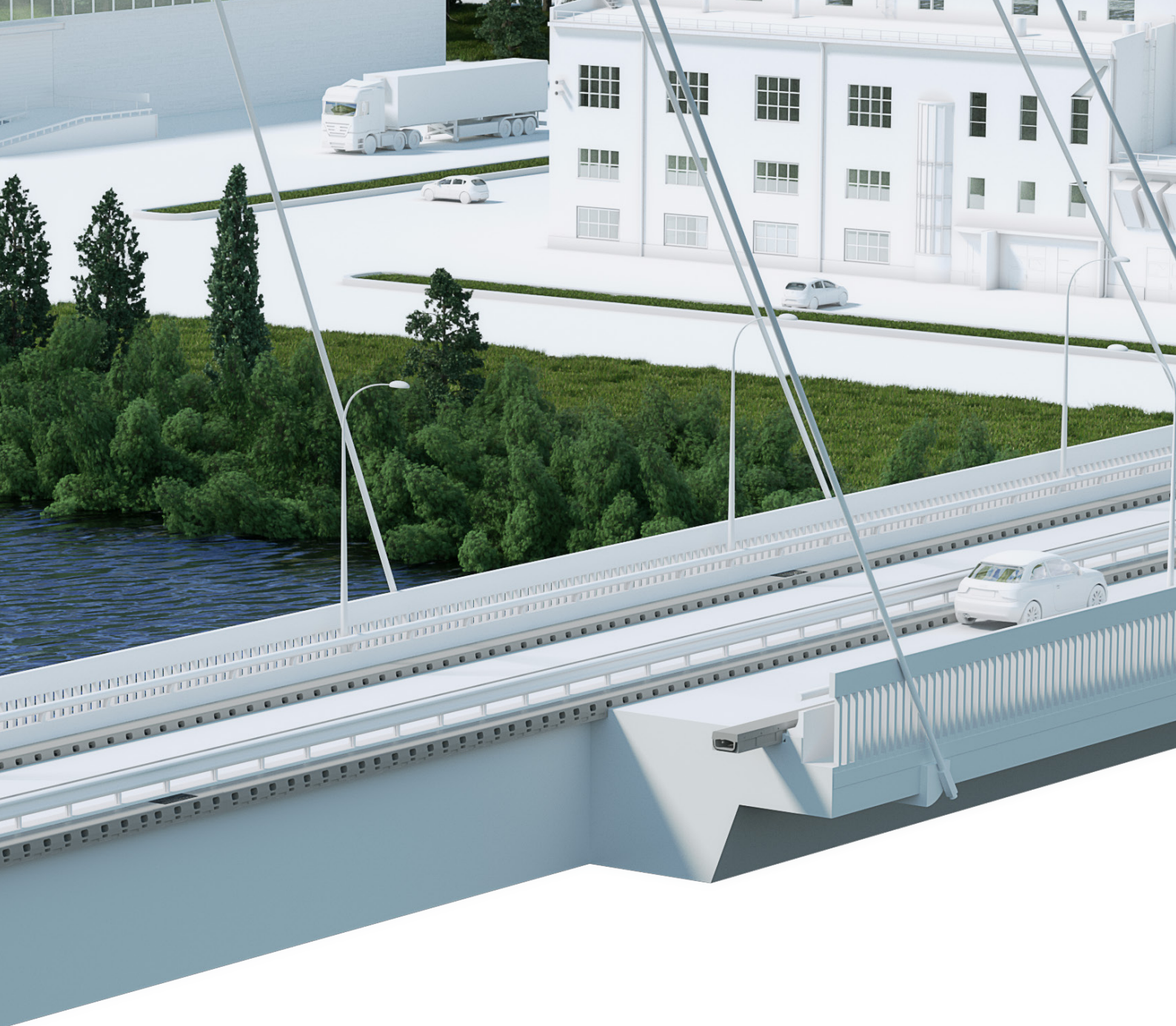

## ACO DRAIN® KerbDrain Bridge for the linear bridge drainage

Bridges are particular key points in road traffic. The requirements for their drainage systems are correspondingly high. Surface water must be drained quickly and effectively to avoid aquaplaning or black ice formation on bridges.

Traffic safety must be guaranteed at all times – and this with the longest possible service life of the bridge. The KerbDrain Bridge represents a new form of linear drainage of bridges. The construction is a kerb channel that combines border stone/kerb and drainage.

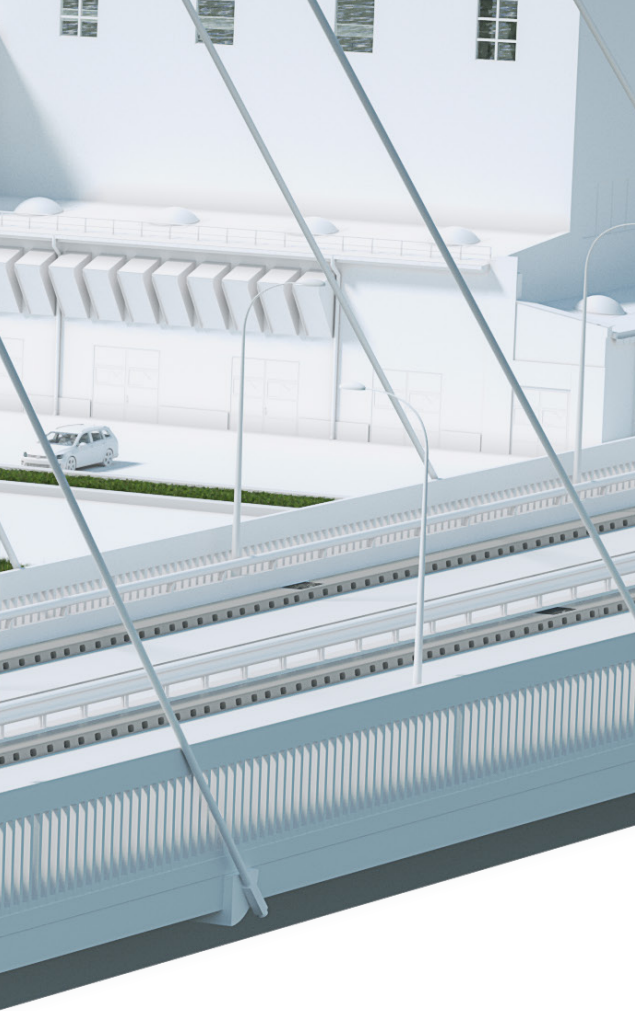

ACO Group	4
-----------	---

---

<b>Drainage of bridges</b>	<b>7</b>
----------------------------	----------

Material and installation site	8
--------------------------------	---

Powerful and easy to service	9
------------------------------	---

Functional design	10
-------------------	----

Advantages	11
------------	----

Installation	12
--------------	----

Connection	13
------------	----

“Off the road – into the cap”	14
-------------------------------	----

Hollow kerb channels with extra high residual kerb height	15
---	----

---

Installation recommendation	16
-----------------------------	----

Product drawings	17
------------------	----

ACO WaterCycle	18
----------------	----

# ACO. we care for water

ACO is a Water-Tech company that protects water. Building on our global drainage expertise that protects people from water, we increasingly see our mission as also protecting water from people.

With the ACO WaterCycle, ACO provides systems that collect and channel, clean, retain and ultimately reuse water. In this way, ACO contributes to the preservation of clean groundwater as a vital resource, and makes a contribution to tomorrow's world. In its Agenda 2030, the UN global community set the improvement of water quality as one of 17 sustainable development goals.

Intelligent drainage systems from ACO increasingly use smart technology to ensure that rainwater and wastewater are drained, or temporarily stored. With innovative separation and filter technology, we prevent water contamination by pollutants such as fat and grease, fuels, heavy metals and microplastics.

Today, ACO goes one step further: we accept the challenge of reusing water, and thus establishing a resource-saving cycle. For all products and systems, ACO attaches great importance to durability, reusability and a low carbon footprint. The pursuit of sustainability is an ongoing process that we strive to meet every day.

The ACO Group is a global family business that is one of the world market leaders in the Water-Tech segment. Founded in Schleswig-Holstein in 1946, it operates as a transnational network in over 50 countries. Worldwide, ACO is characterised by a high level of decentralised ownership, and explicit regional market proximity.

[www.aco.com](http://www.aco.com)



Holder  
Iver and Hans-Julius Ahlmann



Headquarters of the ACO Group  
in Rendsburg/Büdelndorf



**5,300**

employees in more than 50 countries (Europe, North and South America, Asia, Australia, Africa)

**1.15 Billion**

Euro Sales in 2022

**40**

production sites in 20 countries



ACO Academy  
for practical training

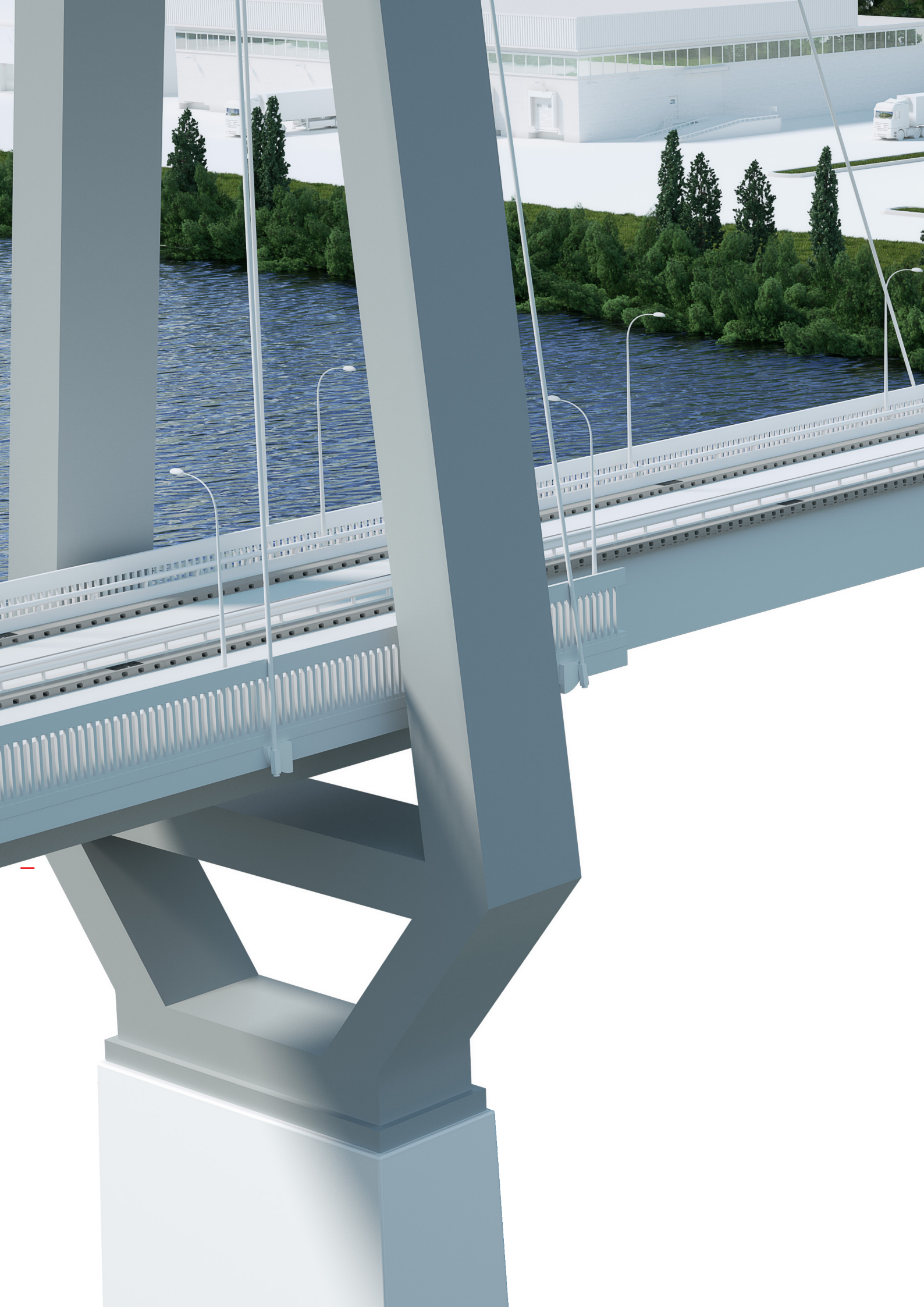

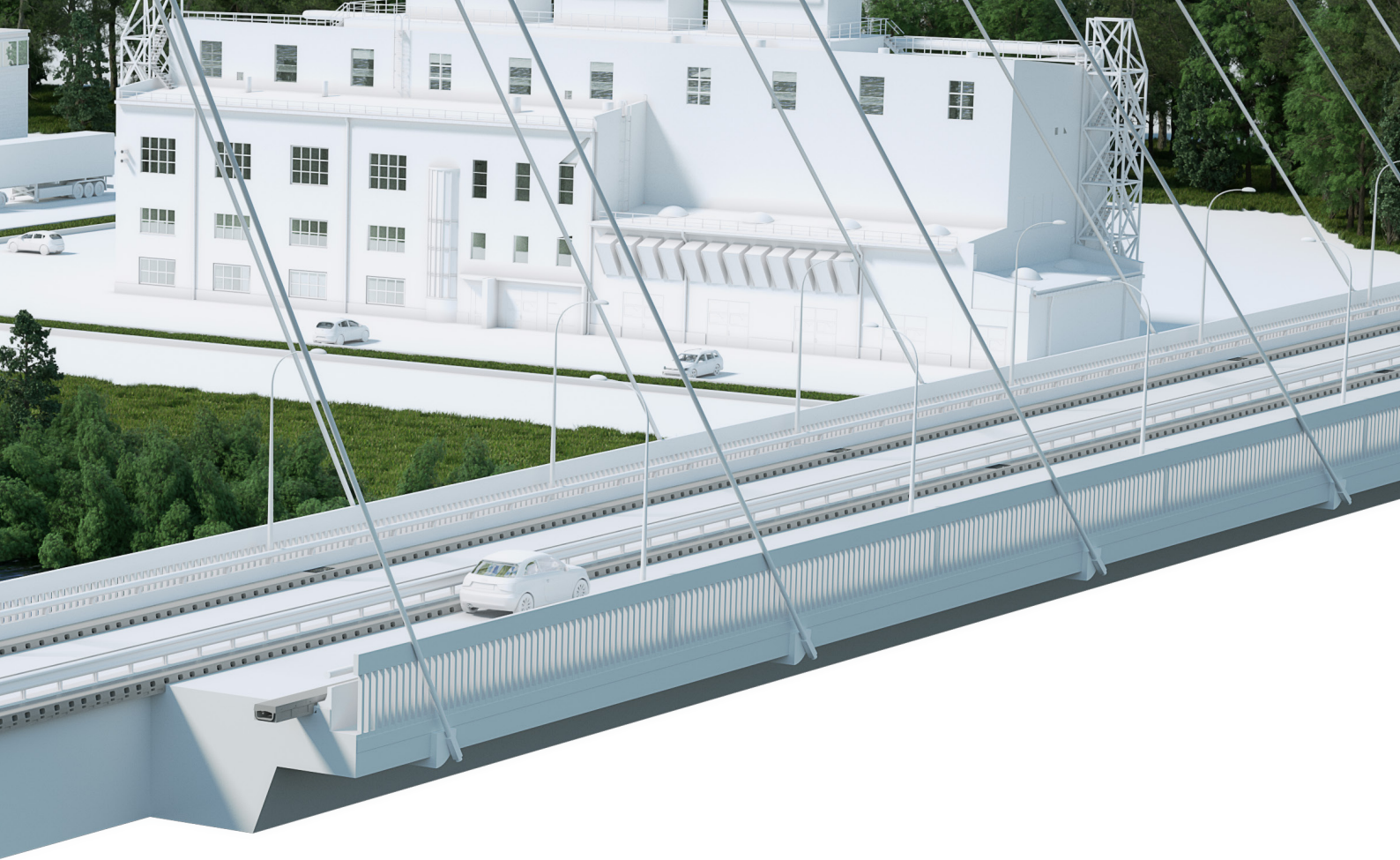

## drainage out of the track

### Drainage of bridges

#### Technical characteristics

The ACO DRAIN® KerbDrain Bridge KD 200-75 was developed to give builders, planners, architects and operators the opportunity to design and plan the drainage of bridges with a new approach to linear bridge drainage.

Another special advantage compared to conventional bridge gullies and drainage channels with gratings is the positioning in the area of the cap that is not driven over and the powerful drainage with a low longitudinal gradient. The design of larger section lengths and the associated reduced number of penetrations of gullies in the bridge construction increase the safety of execution and durability. The integrated seal has proven itself as standard equipment and is used for extended protection of constructions.

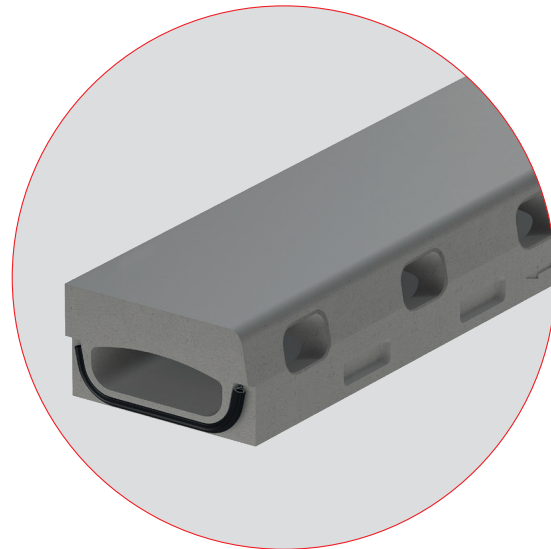

## high drainage capacity despite a low gradient

## Material and installation site

### Material

Thanks to the polymer concrete that has been tried and tested in the drainage area, the KerbDrain Bridge is highly stable and rustproof as well as frost and chemical resistant. The increased use of de-icing salts is an important issue for the durability of the drainage channel, especially when paving porous asphalt. The use of the channel is technically easy to implement and more cost-effective than other linear bridge drainage systems.

### installation site

The ACO KerbDrain Bridge KD 200-75, also in the version with covering layers made of porous asphalt (OPA), is a linear drainage system for the roadside. KerbDrain is a combined kerb and drainage system specifically designed and developed to form an integral part of any modern bridge drainage solution.

The design for the bridge drainage has been developed according to the requirements of the German market and

reflects our experience with the use of kerb channels for municipal and tunnel drainage. The specifications of a very low installation depth, a high drainage capacity, an impact-resistant construction and the comparable standard drawing requirements are fully implemented in the end product.

**stable  
construction**

**high drainage  
performance**

**ACO polymer  
concrete**

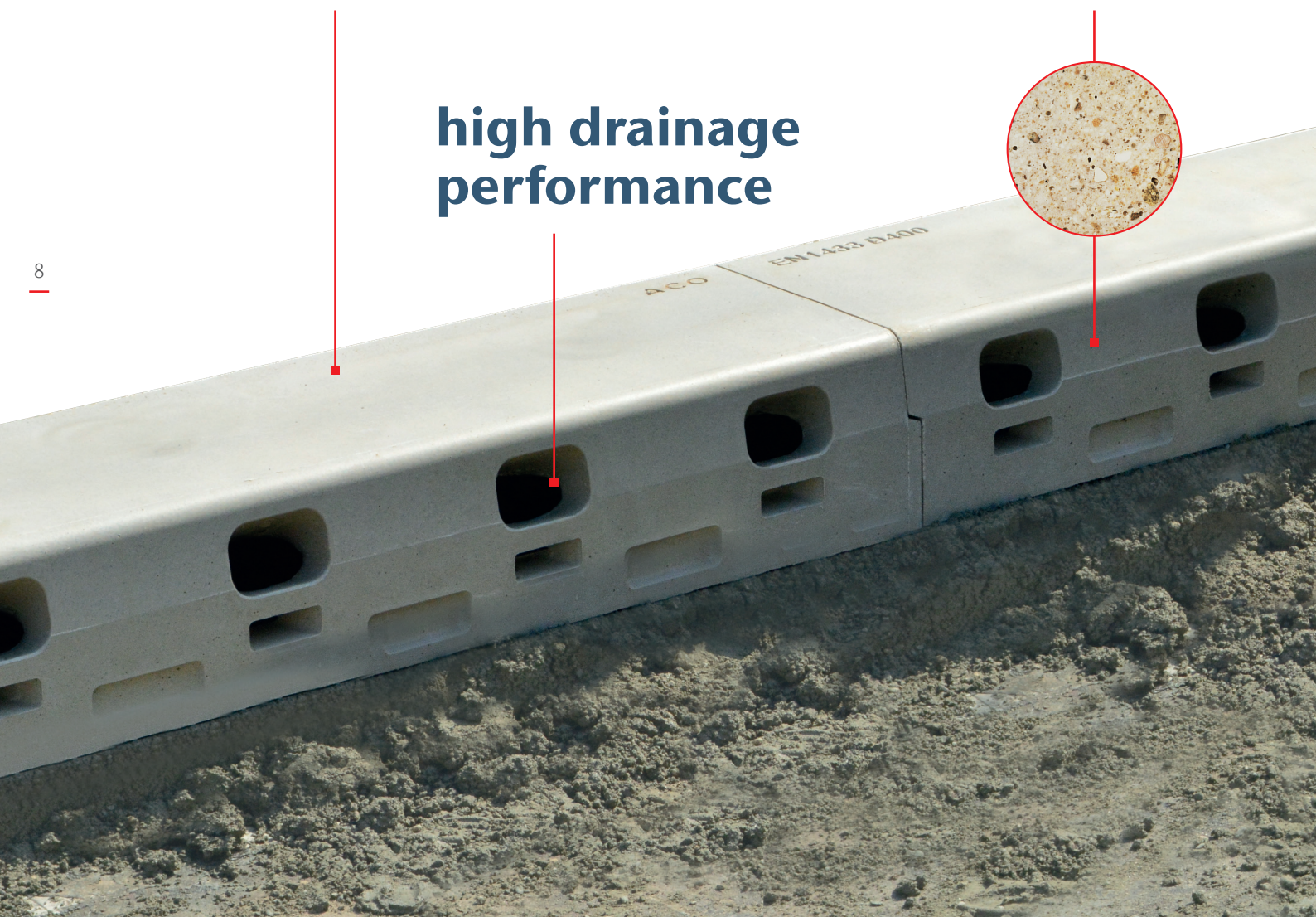



## Powerful and easy to service

### Powerful

Nominal size and inside cross-section width are 200 mm. A second drainage version of the KerbDrain Bridge is available for bridges with porous asphalt (OPA). The inside height in the flow cross-section is 63 mm in the standard configuration and 83 mm for the OPA version. The resulting flow cross-section, measured up to the top edge of the road, is 96 cm<sup>2</sup> in the standard and 132 cm<sup>2</sup> in the OPA version. The KerbDrain Bridge KD 200-75 has four holes per metre with a width of 90 mm and an inlet height of 60 mm as inlet openings.

A maximum installation tolerance of 10 mm is available for the channel and asphalt to ensure reliable drainage. All this makes the KerbDrain Bridge KD 200-75 and KD 200-75 OPA the most powerful linear bridge drainage.

### Service friendly

Two versions of inspection openings are available for inspection and maintenance of the KerbDrain Bridge. The inspection opening has a smaller hinged cast port with the Powerlock screwless safety

lock. The large inspection opening is provided with a hinged gully top. The gully top opens lengthwise to the bridge cap and thus does not come into conflict with the protective device of the bridge. The dimensions of the inspection opening are designed so that the rinsing hose and suction socket fit. The connection to the bridge drainage line is located below the inspection opening. The piping can also be flushed via this access.



◀ KerbDrain Bridge KD 200-75 with inspection openings

- 1** Width: **280 mm**
- 2** Height: **155 mm** (OPA: 175 mm)
- 3** Inside cross-section width: **200 mm**
- 4** Inside height: **60 mm** (OPA: 83 mm)
- 5** Inlet opening: **90 x 59 mm**
- 6** visible height: **75 mm**
- 7** effective flow cross-section: **96 cm<sup>2</sup>** (OPA: 132 cm<sup>2</sup>)

Basic representation  
Installation of KD 200-75 OPA

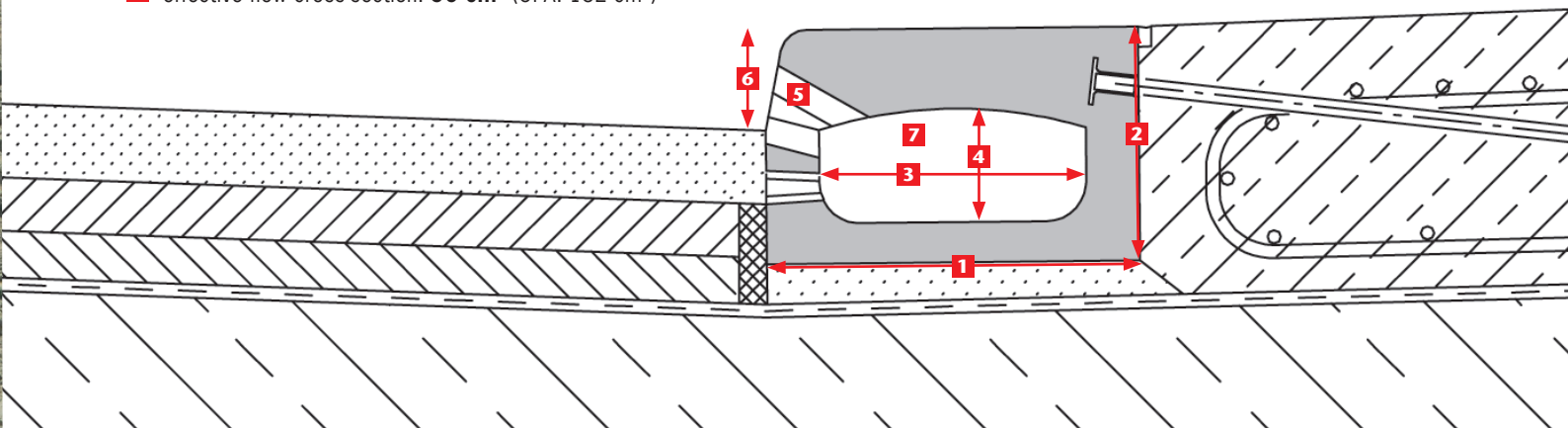

## Functional design

The KerbDrain Bridge KD 200-75 is designed for load class D 400. This means that it is possible to run over it with a truck. A transverse installation is of course prohibited because of the board. The front-side of the channel is designed to absorb the vertical load of 400 kN and to transmit the horizontal impact forces directly into the cap concrete.

On the back of the channel there are anchor sleeves for 4 x 50 cm M12 threaded rods for securing in accordance with the guide drawing in Chapter

12. With the installation of the anchoring steels in the anchor sleeves, the grouted anchor is given and the channel thus becomes part of the bridge cap. There are four anchor sleeves in the ACO polymer concrete for this purpose. The inclination of the anchor sleeves ensures the necessary concrete covering of the anchor steels and is intended to prevent collisions with the cap reinforcement. The number and length of the anchor steels are pre-measured in the standard configuration. There are pockets on the front and back that additionally anchor the channel in asphalt and cap concrete.

**vertical load  
400 kN**

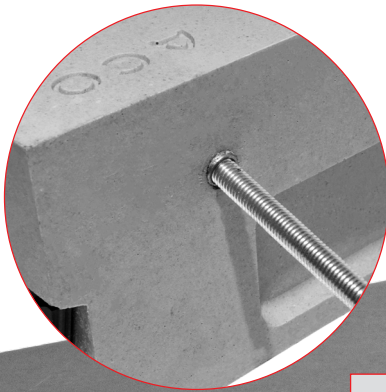

secure grouted anchor  
in the bridge cap

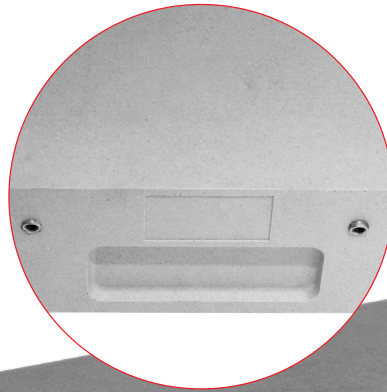

high stability against  
impact loads

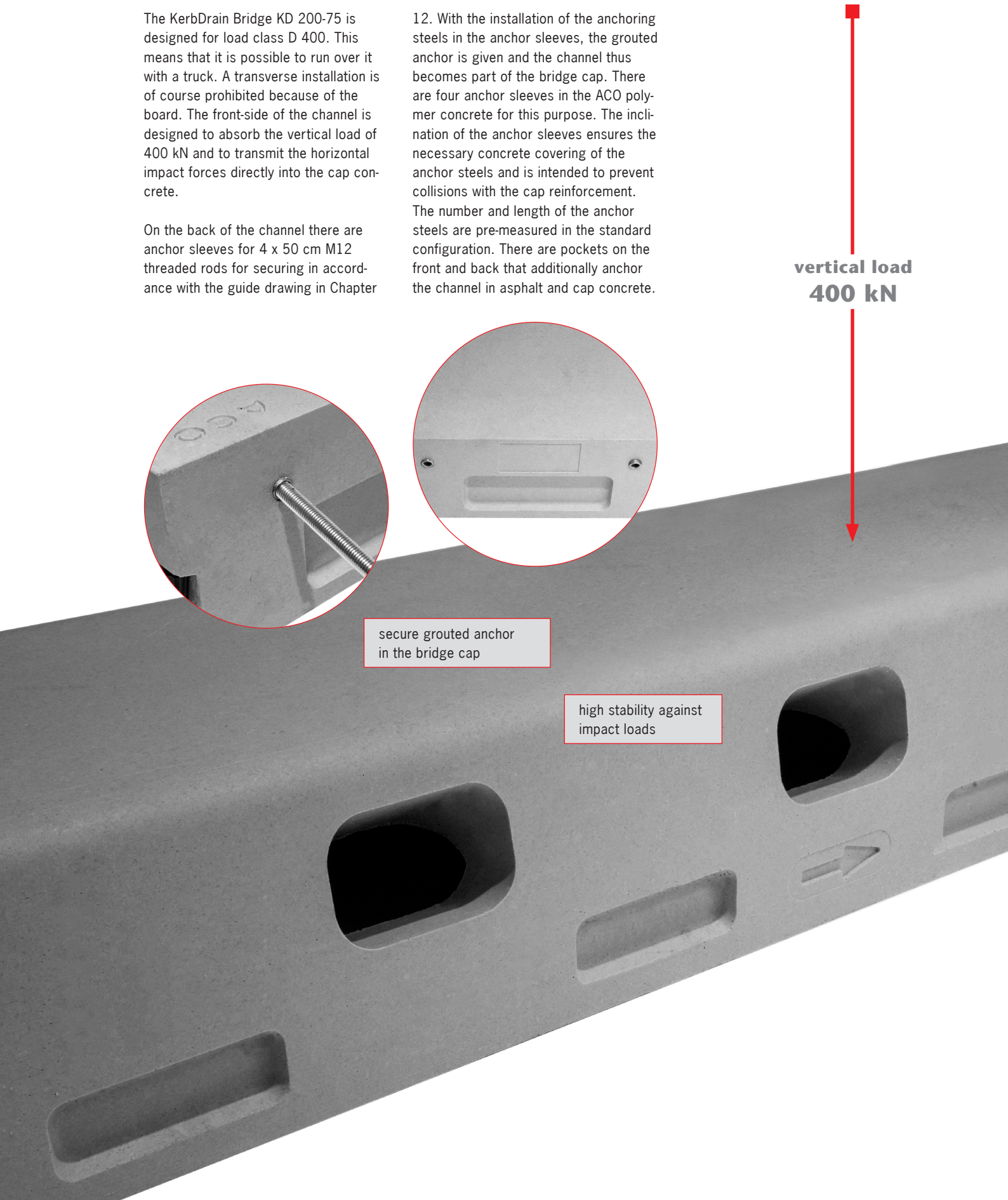

## Advantages

### Safe drainage for every gradient

The advantages of the KerbDrain Bridge KD 200-75 come into play above all in drainage situations with a low longitudinal gradient. If there is no or very little longitudinal gradient, the connection to the roadway to be drained is possible without further measures. An artificial gradient in the road surface or in the edge area, as is required for bridge gullies, is not necessary.

As the slope increases, the surface water has to be continuously removed in order to drain it away in a concentrated and safe manner. When using bridge gullies, the flow velocity and the amount of water that a gully has to absorb increase with increasing distance. The water flow takes place at the edge of the roadway and thus the width of the water level increases directly at the edge of the roadway.

The drainage with the KerbDrain Bridge, on the other hand, is separated from the roadway. An increasing longitudinal gradient increases the discharge capacity of the KerbDrain Bridge.

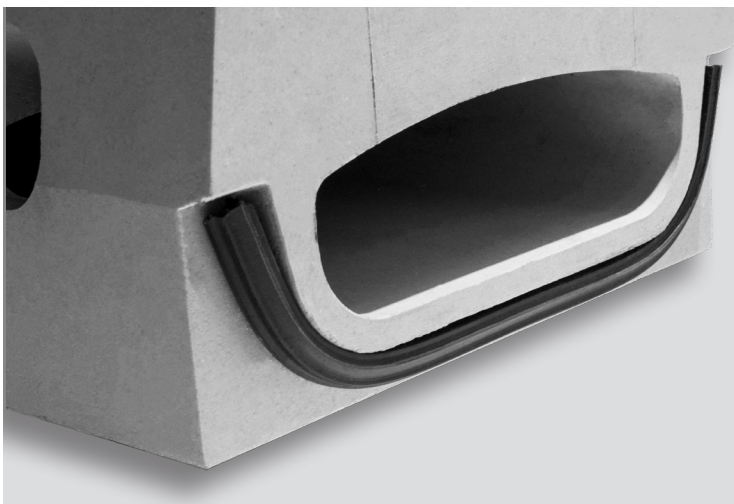

### Less channel contamination

Another aspect is the contamination of the systems. As surface water decreases every 25 cm, the hydraulic force that carries dirt ingress from the roadway into the KerbDrain Bridge KD 200-75 is reduced accordingly. When using conventional bridge drains, on the other hand, surface water is collected in the edge area over a longer stretch. The hydraulic power increases and transports significantly more dirt to the drain point.

## Project specific planning

ACO Civil Engineering supports everyone involved in the construction right from the planning stage. With technical advice and solution-oriented product details as well as a hydraulic performance calculation, quick and precise statements can be made about drainage channels. For more information, visit:

- Linear bridge drainage, also for porous asphalt (OPA)
- Drainage in the area of the cap
- Monolithic curb drainage made of polymer concrete
- With integrated seal
- Grouted anchor – guide drawing chapter 12
- For new construction and renovation
- Load class: D 400

[www.aco.de/kerbdrain-bridge](http://www.aco.de/kerbdrain-bridge)

## Installation

The KerbDrain Bridge is laid on a mortar bed made of PCC (Polymer Cement Concrete). Recommended by the Federal Highway Research Institute Germany. The directional installation is carried out from above to the already offset KerbDrain Bridge channel.

Since the KerbDrain Bridge is part of the bridge cap and is installed before it is concreted, the channel serves as stay-in-place formwork on the road side. The installation of the channel for the roadway and cap is therefore decisive for the alignment and the final heights.

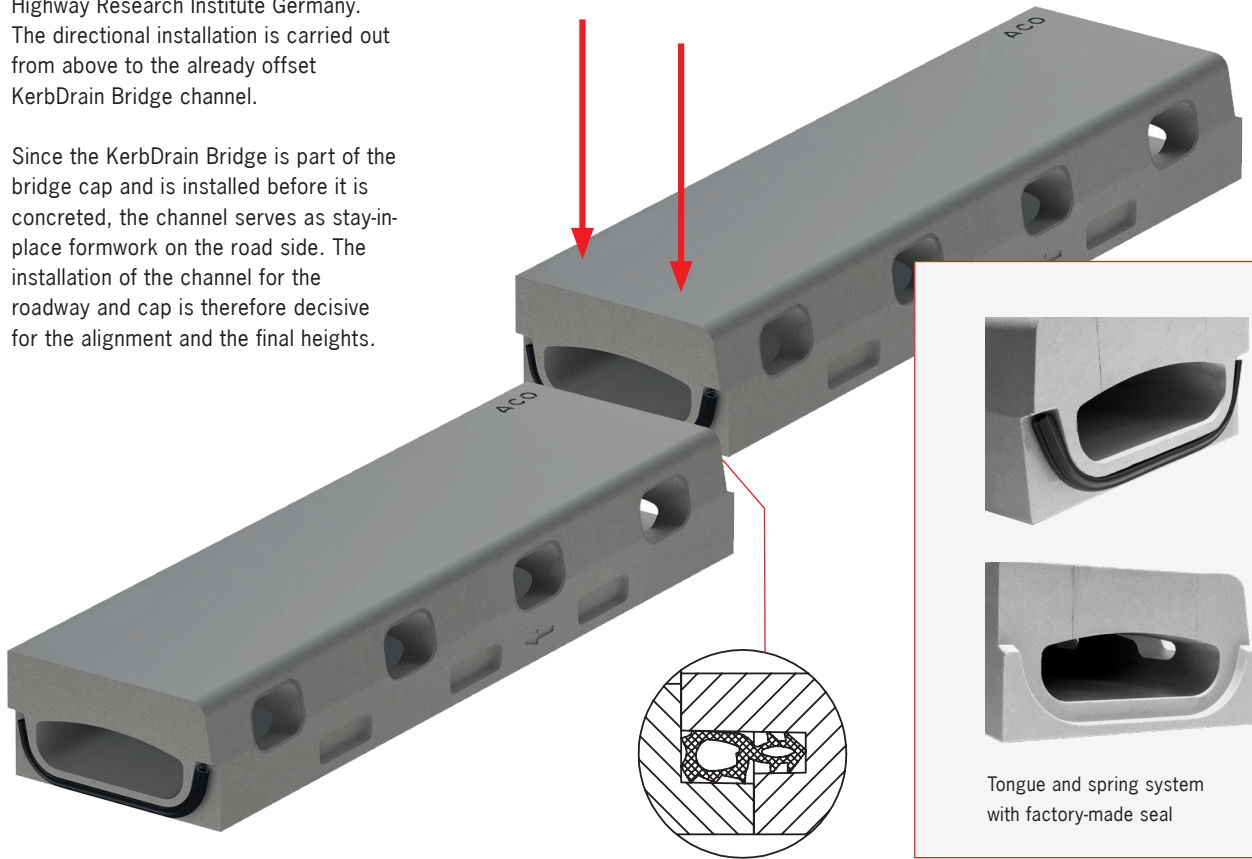

Tongue and spring system with factory-made seal

### Grouted anchor

On the back of the KerbDrain Bridge there are four screw anchor sleeves for the subsequent installation of M12 steel anchors. The length is defined as 50 cm or according to the static information. The anchorage is included in the cap reinforcement as specified.



### Seal

The channel elements of the KerbDrain Bridge have an EPDM seal as standard. The tightness of the channel joint results from the pressing effect of the tongue and spring construction of the front sides on the integrated seal.



### Routing

The specified line of the installed channel run makes it easier to apply the road surface and the cap concrete.



## Connection

The connection or transition via the expansion joint at the abutment transition is **not** planned. As a result, drainage is interrupted at the expansion joint. The channel is closed at the front-side by an end wall and provided with a connection to the drainage pipe. Section lengths are delimited with a inspection element and a vertical DN/OD 160 outlet.

Distances result from the hydraulic calculation and the structural circumstances on the bridge structure. The drainage channel itself runs continuously without intermediate partitions.

The KerbDrain Bridge offers a vertical connection option with a lip labyrinth seal in the invert. A pipe socket is installed here as an intermediate piece in order to drain directly into the casting outlet installed below. In order to drain any leachate that may occur, the mortar bed in this area must be designed to be drainable.



## Drainage with vertical outlet

- 1** Inspection element large
- 2** ACO KerbDrain Bridge KD 200-75 OPA flow cross-section
- 3** Vertical gully/pipe socket
- 4** Gully with vertical outlet
- 5** Connection to the bridge drainage line

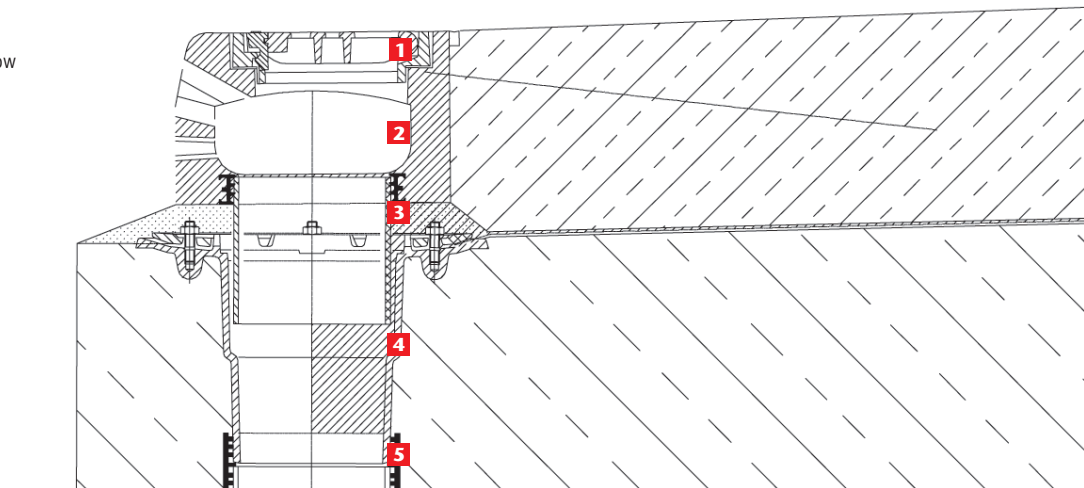

## “Off the road – into the cap”

Those responsible for bridges always have worries and concerns when the drainage systems are constantly being driven over during construction site traffic management. The special advantage of the ACO DRAIN® KerbDrain Bridge KD 200-75 – compared to conventional bridge drains and drainage channels with grates – is the positioning in the area that is not driven over.

The specifications of a very shallow installation depth, a high drainage capacity, an impact-resistant construction and the orientation towards the standard drawing requirements are fully implemented in the end product.

The linear drainage system is based on a channel body made of waterproof, frost-resistant polymer concrete. The butt joint between the channel elements is permanently and securely sealed with an EPDM seal integrated as standard. The special channels of load class D 400 according to DIN EN 1433 have inlet openings arranged on one or two levels (OPA version).



A hinged, large inspection opening is available for inspection and maintenance of the KerbDrain Bridge. The gully top folds along the bridge cap. Below the inspection opening is the connection to the bridge drainage line, through which the piping can also be flushed.

The surface water is guided through the transverse inclination to the channel and from there it is taken up over the entire length. There is no need for a separately produced longitudinal slope in the roadway surface or in the edge area, as is often the case with bridge gullies. Due to the gravity or water surface slope, a comparatively higher discharge is achieved even without a longitudinal inclination.



The pre-installed drainage channel is a defined interface and reference line for further trades. Additional functions result after installation: The upper and front edge of the cap, the top edge of the road and the overall gradient guidance are defined as stay-in-place cap formwork. Thanks to its optimal dead weight and the technical anchoring between the channel elements and the adjacent bridge components, the KerbDrain Bridge integrates perfectly into the bridge.



## Hollow kerb channels with extra high residual kerb height

The safety of all road users must be guaranteed on bridge structures. According to the current guidelines "RPS, guidelines for passive protection on roads by restraint systems, version 2009", it is therefore sufficient on inner-city bridges (two-lane overpass and  $V_{all} \leq 50$  km/h) to use a raised kerb with 15 cm kerb height and a railing with rope according to RiZ-Ing. Here, a 15 cm kerb is considered to be "not driveable" and further protection devices (according to traffic calming level H1) are therefore not required.

### ACO DRAIN® KerbDrain Bridge City

In order to meet this need, the previous KerbDrain Bridge system has been further developed. The difference in the new channel ACO KerbDrain Bridge City lies in the so-called residual kerb height. This has been increased from the previous 7.5 cm to 15 cm. This means that the established installation edge has also been integrated here.

The family of hollow kerb channels is an integral part of the current guideline "REwS – Guideline for Drainage 2021".

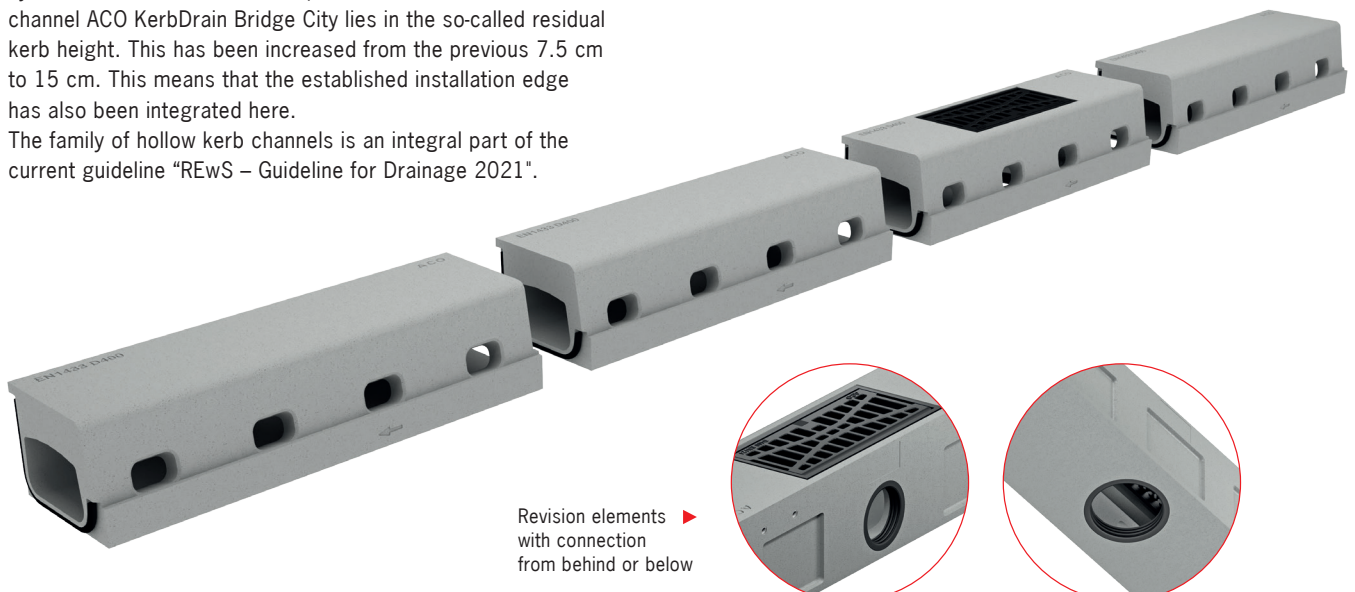
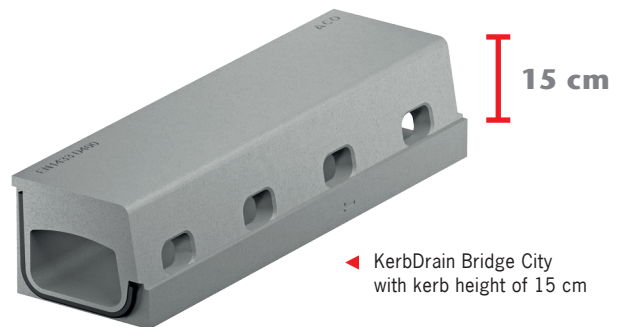

#### Note

For more information, please visit the ACO Website:  
**KerbDrain Bridge City**

## Installation recommendation

based on the Federal Highway Research Institute Germany standard drawings chapter 12

### Standard installation without mastic asphalt

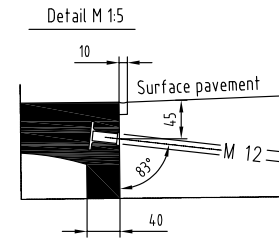
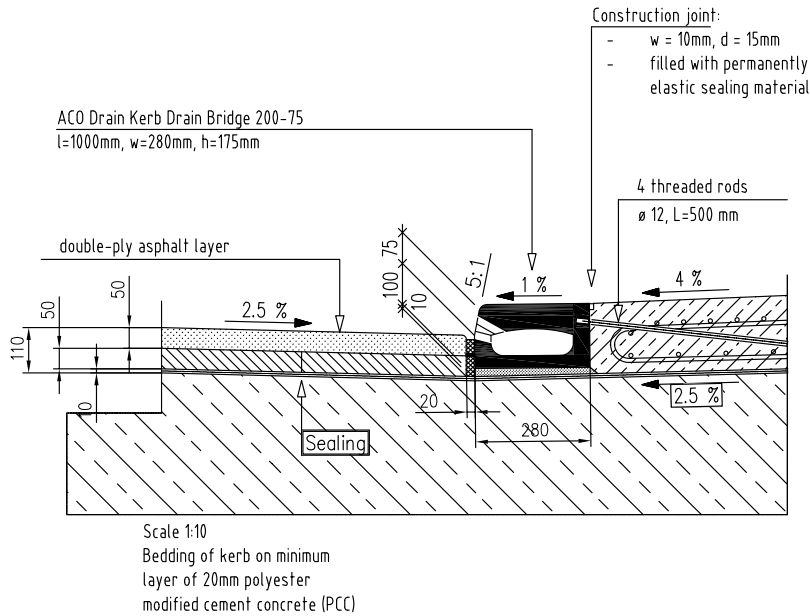

- Anchoring:
- Threaded bushing with welded foot sheet
  - Threaded rod M12, l=500mm, in distance of 250mm made of stainless steel 1.4401 or 1.4571

### Installation with porous asphalt

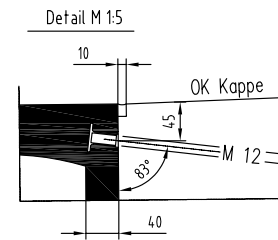
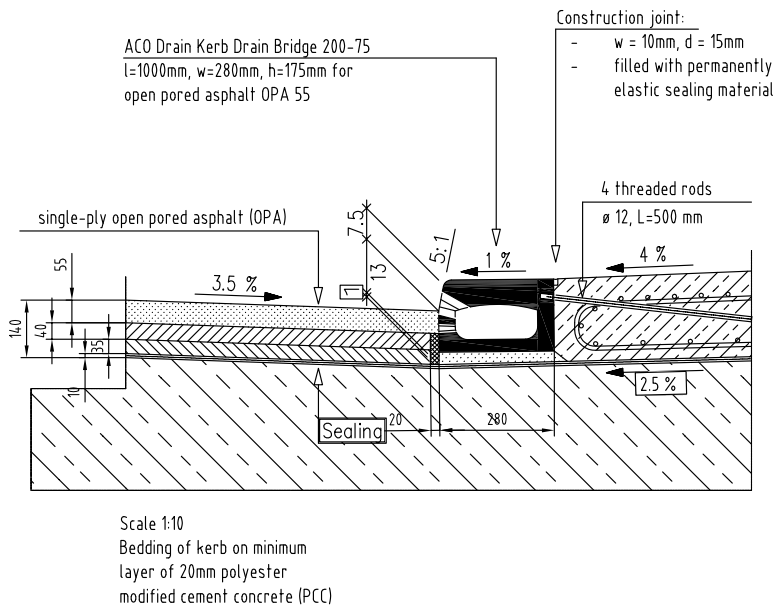

- Anchoring:
- Threaded bushing with welded foot sheet
  - Threaded rod M12, l=500mm, in distance of 250mm made of stainless steel 1.4401 or 1.4571

#### Note

For a project-related installation recommendation, please use our technical application service:

[kundencenter@aco.com](mailto:kundencenter@aco.com)



## Product drawings

### Standard KerbDrain Bridge KD 200-75

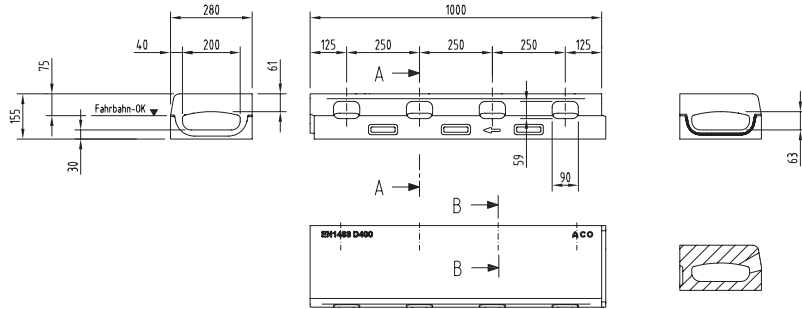
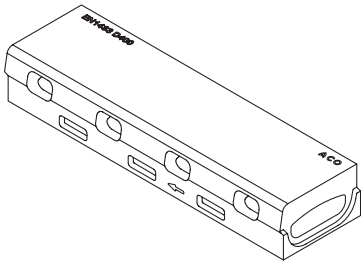

### Standard KerbDrain Bridge Inspection element

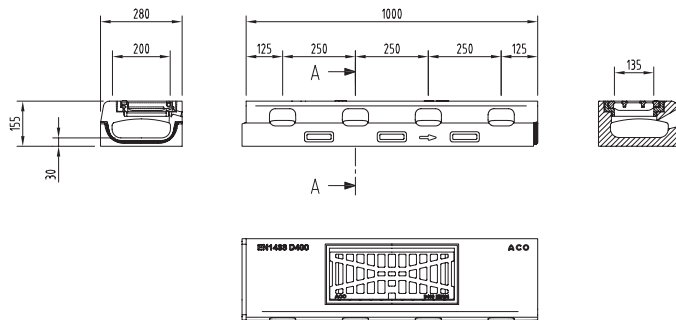
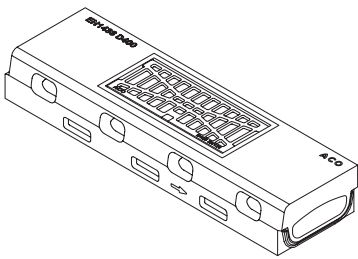

### KerbDrain Bridge KD 200-75 OPA

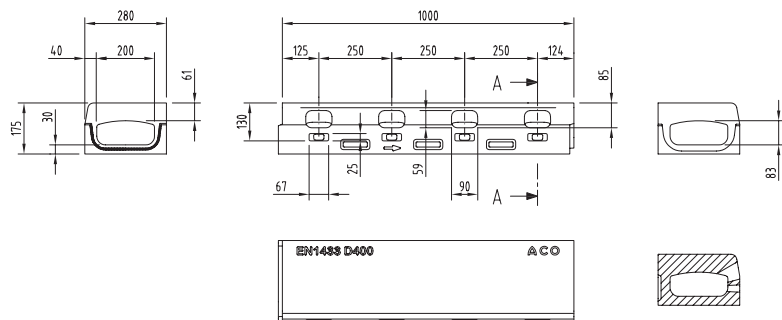
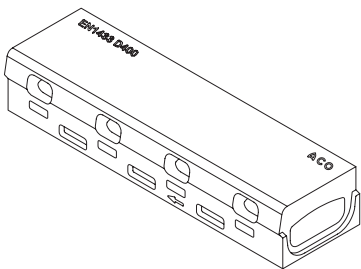

### KerbDrain Bridge Inspection element OPA

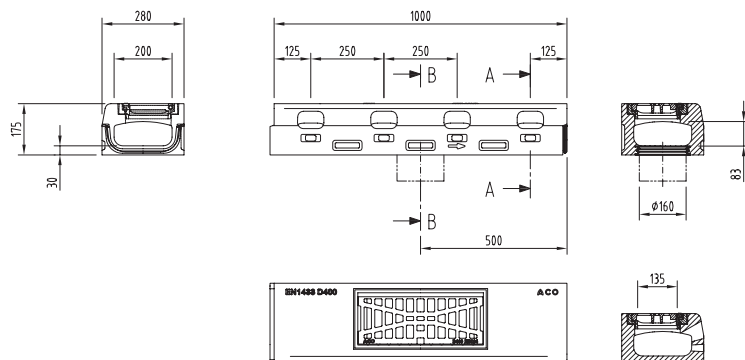
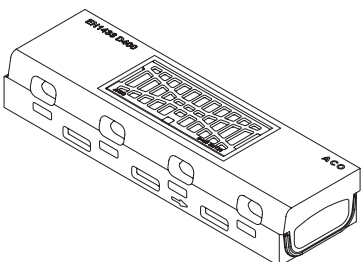

# ACO WaterCycle



The ACO WaterCycle supports you at every stage of drainage planning. This is rainwater management for the environmental conditions of tomorrow.

Where surface water management and water protection begins



## ACO surface water drainage

- Drainage channels
- Road and yard drains
- Gully tops
- Manhole covers



Achieving the right water quality



## ACO cleaning systems

- Separators
- Sedimentation and filtration systems

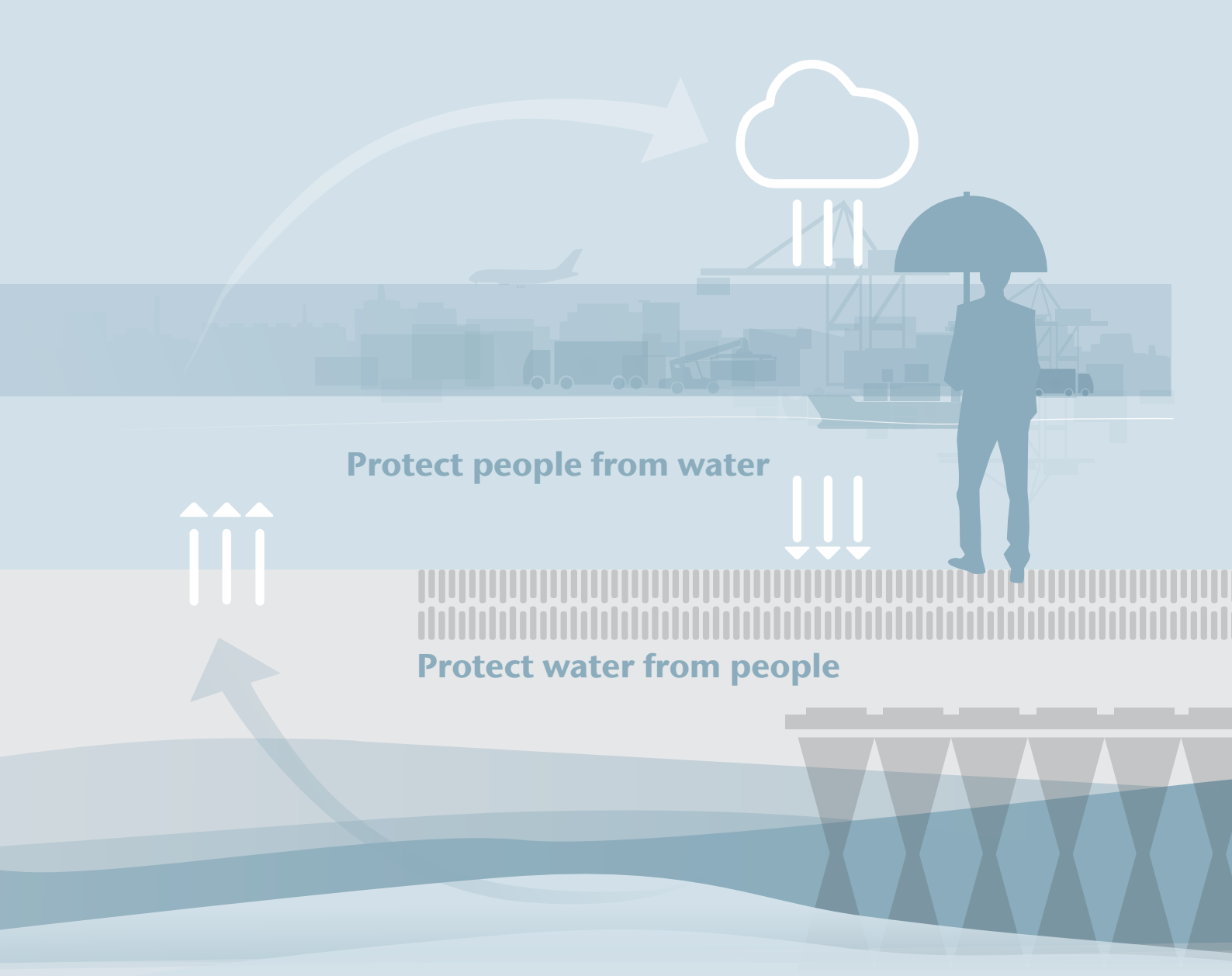

Protect people from water

Protect water from people

Reducing surface runoff to a natural level

Control discharge rate to the required level

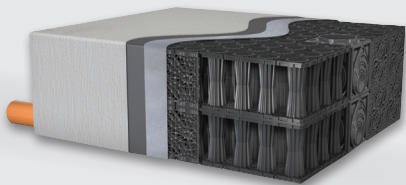

**ACO retention and storage systems**

- Emergency systems
- Infiltration and attenuation systems
- Surface water retention basin



**ACO control systems**

- Flow control systems
- Pump shafts

# ACO. we care for water

Intelligent drainage systems from ACO increasingly use smart technology to ensure that rainwater and wastewater are drained, or temporarily stored. With innovative separation and filter technology, we prevent water contamination. We accept the challenge of reusing water, and thus establishing a resource-saving cycle.

ACO S.p.A.

Via Beviera, 41  
42011 Bagnolo in Piano (RE)  
Tel. 0522 958 111  
Fax 0522 958 255

[info@aco.it](mailto:info@aco.it)  
[www.aco.it](http://www.aco.it)

